



Introduction to Computer Engineering

CS/ECE 252, Spring 2013

Prof. Guri Sohi

**Computer Sciences Department
University of Wisconsin – Madison**

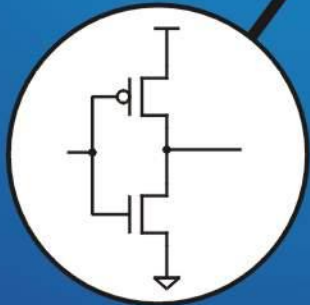
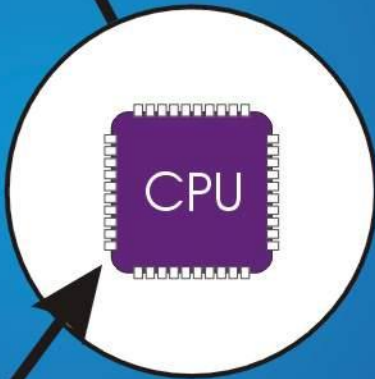
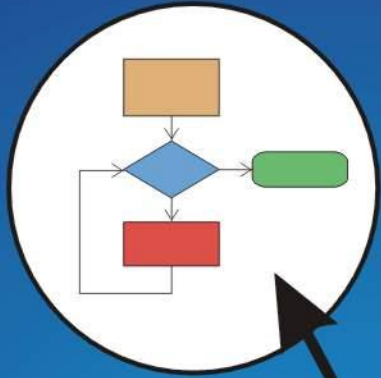

Chapter 6

Programming

Solving Problems using a Computer

Methodologies for creating computer programs that perform a desired function.

Problem Solving

- How do we figure out what to tell the computer to do?
- Convert problem statement into algorithm, using *stepwise refinement*.
- Convert algorithm into LC-3 machine instructions.

Debugging

- How do we figure out why it didn't work?
- Examining registers and memory, setting breakpoints, etc.

Time spent on the first can reduce time spent on the second!

Stepwise Refinement

Also known as **systematic decomposition**.

Start with problem statement:

“We wish to count the number of occurrences of a character in a file. The character in question is to be input from the keyboard; the result is to be displayed on the monitor.”

Decompose task into a few simpler **subtasks**.

Decompose each subtask into **smaller subtasks**, and these into **even smaller subtasks**, etc.... until you get to the machine instruction level.

Problem Statement

Because problem statements are written in English, they are sometimes ambiguous and/or incomplete.

- **Where is “file” located? How big is it, or how do I know when I’ve reached the end?**
- **How should final count be printed? A decimal number?**
- **If the character is a letter, should I count both upper-case and lower-case occurrences?**

How do you resolve these issues?

- **Ask the person who wants the problem solved, or**
- **Make a decision and document it.**

Three Basic Constructs

There are three basic ways to decompose a task:

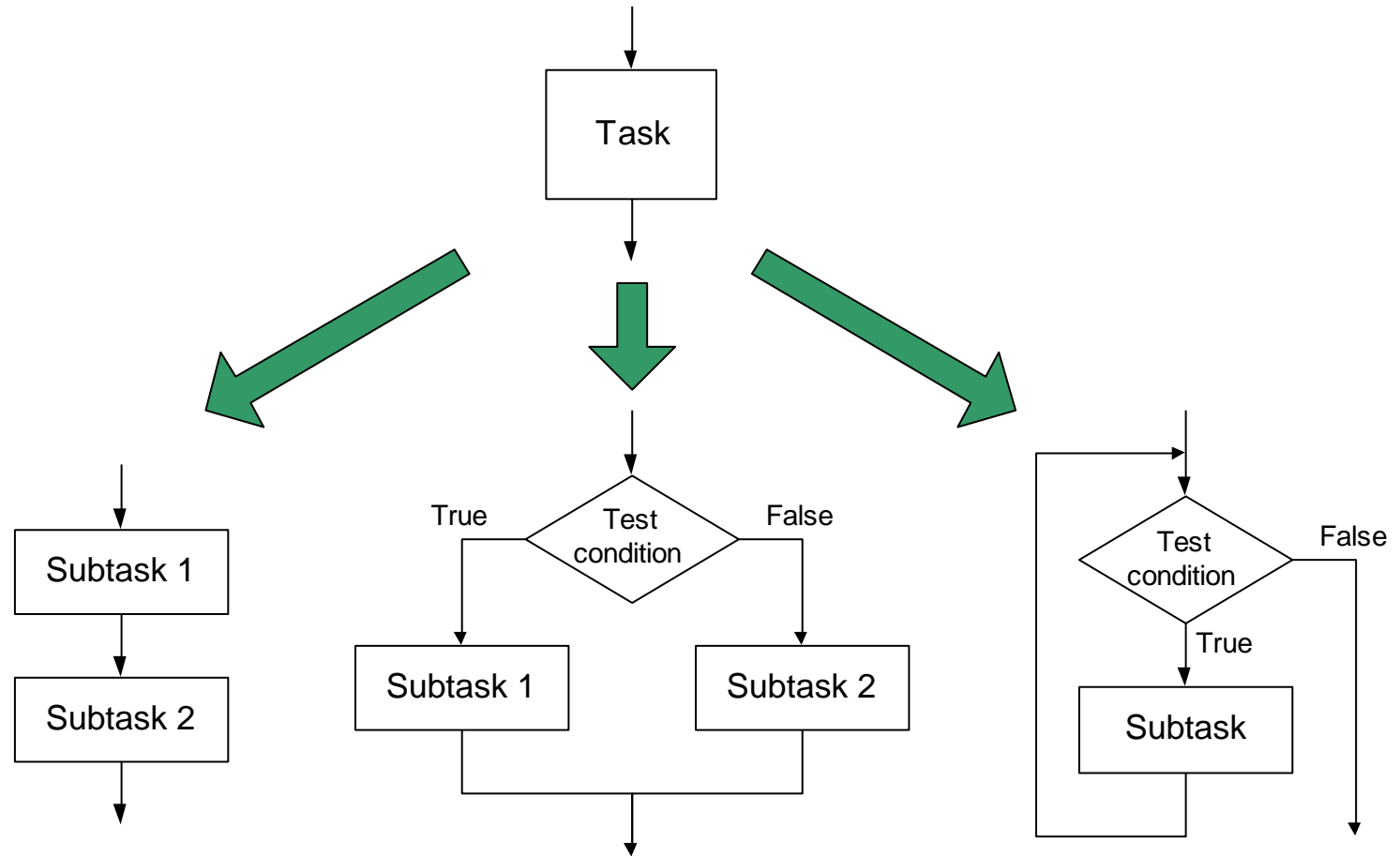

Sequential

Conditional

Iterative

Sequential

**Do Subtask 1 to completion,
then do Subtask 2 to completion, etc.**

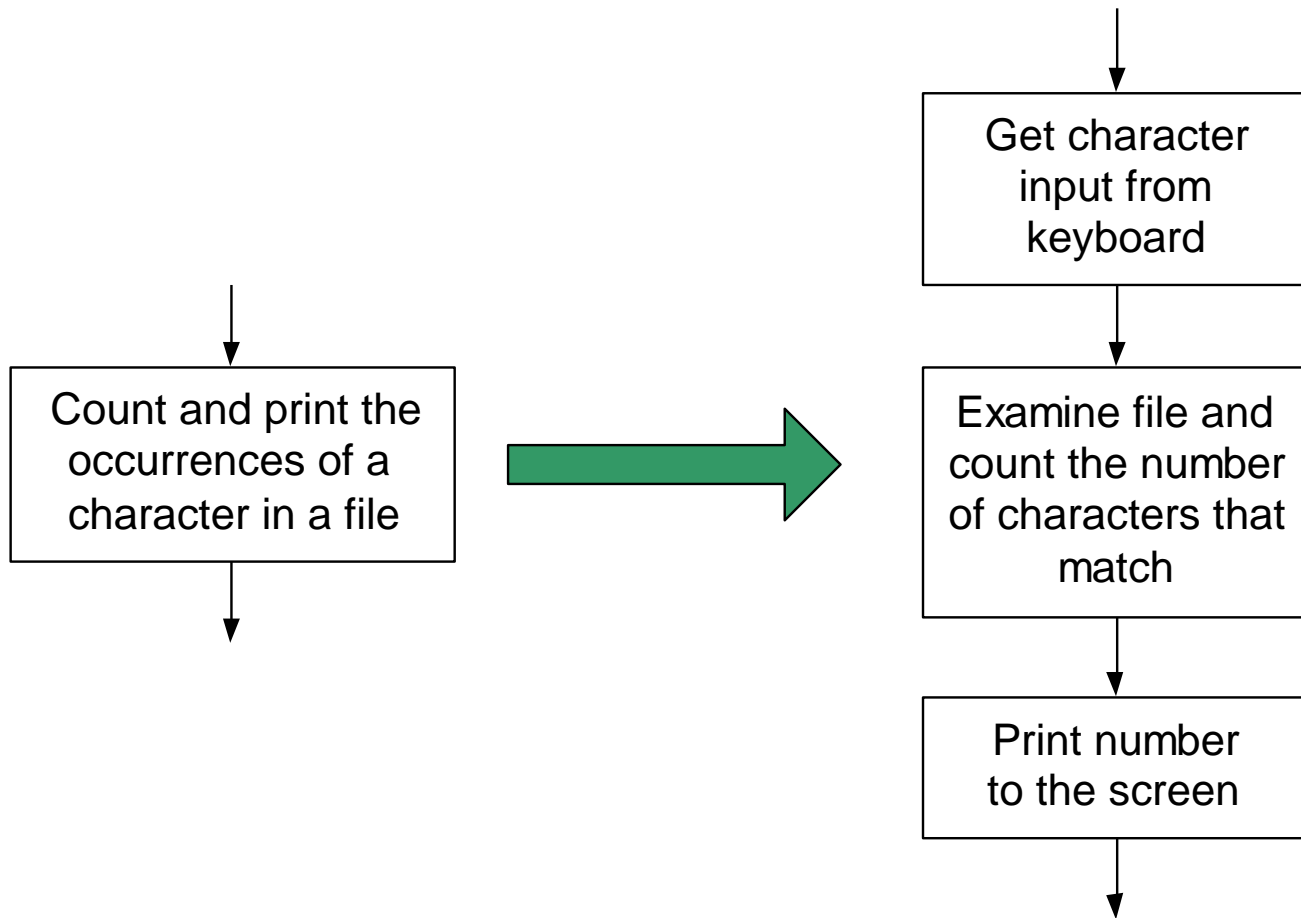

Conditional

If condition is true, do **Subtask 1**;
else, do **Subtask 2**.

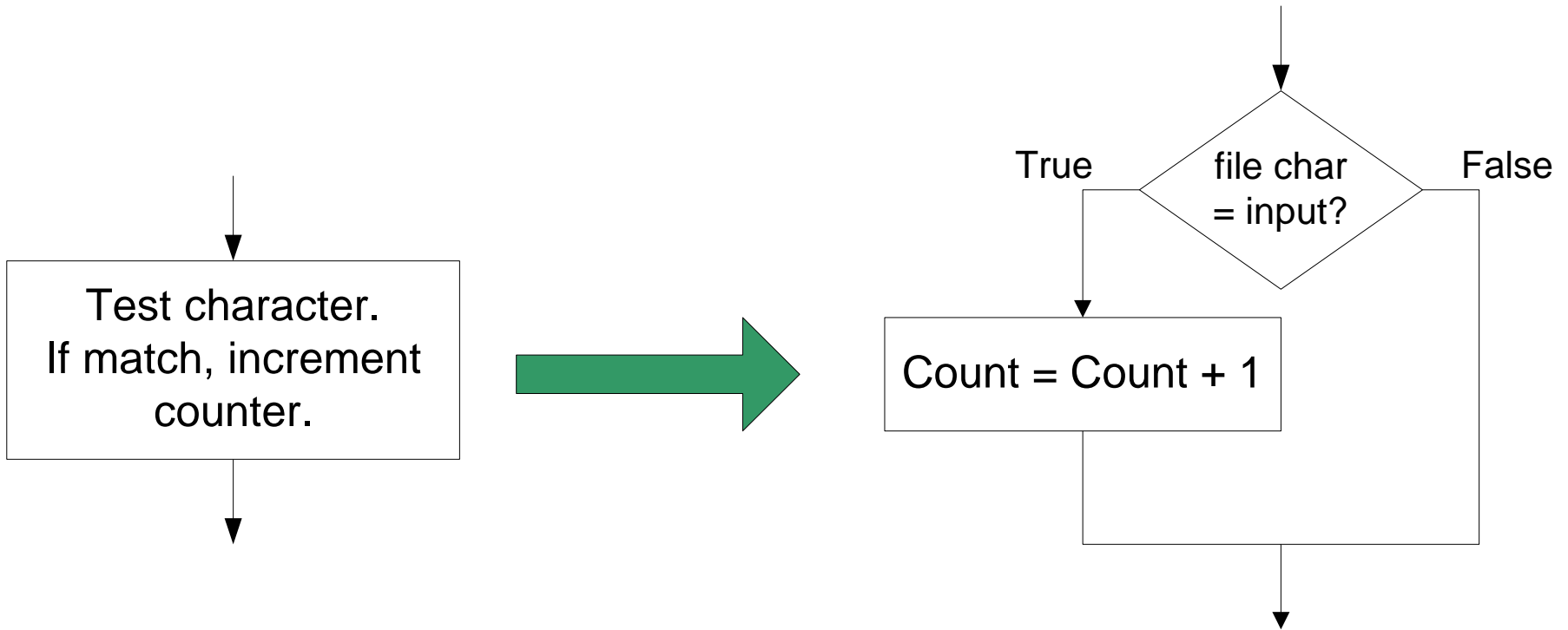

Iterative

**Do Subtask over and over,
as long as the test condition is true.**

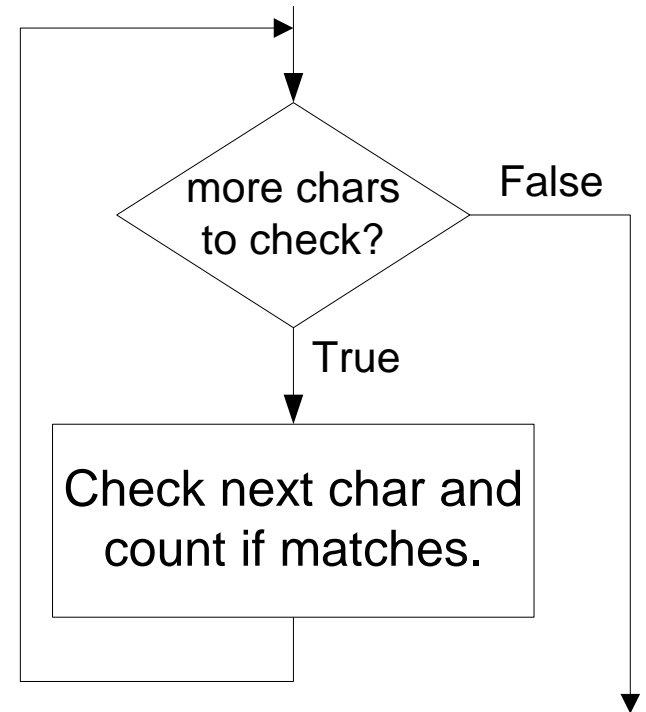
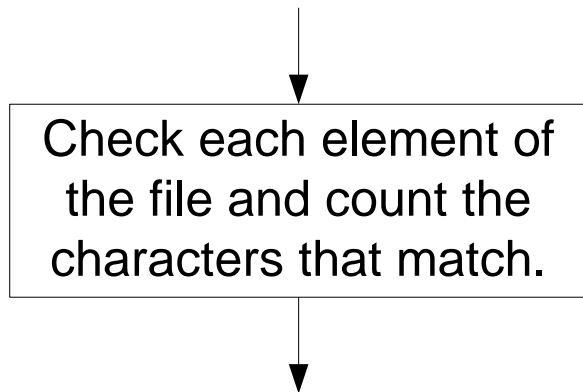

Problem Solving Skills

Learn to convert problem statement into step-by-step description of subtasks.

- Like a puzzle, or a “word problem” from grammar school math.
 - What is the starting state of the system?
 - What is the desired ending state?
 - How do we move from one state to another?
- Recognize English words that correlate to three basic constructs:
 - “do A **then** do B” ⇒ **sequential**
 - “**if** G, then do H” ⇒ **conditional**
 - “**for each** X, do Y” ⇒ **iterative**
 - “do Z **until** W” ⇒ **iterative**

LC-3 Control Instructions

How do we use LC-3 instructions to encode the three basic constructs?

Sequential

- Instructions naturally flow from one to the next, so no special instruction needed to go from one sequential subtask to the next.

Conditional and Iterative

- Create code that converts condition into N, Z, or P.

Example:

Condition: “Is R0 = R1?”

Code: Subtract R1 from R0; if equal, Z bit will be set.

- Then use BR instruction to transfer control to the proper subtask.

Code for Conditional

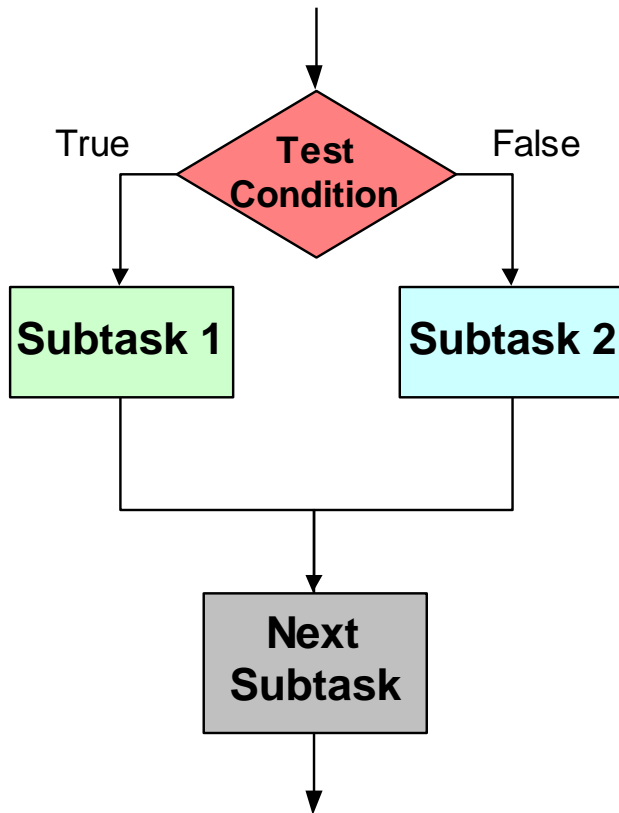

Exact bits depend on condition being tested

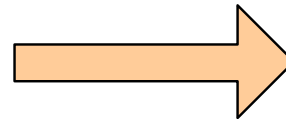

Unconditional branch to Next Subtask

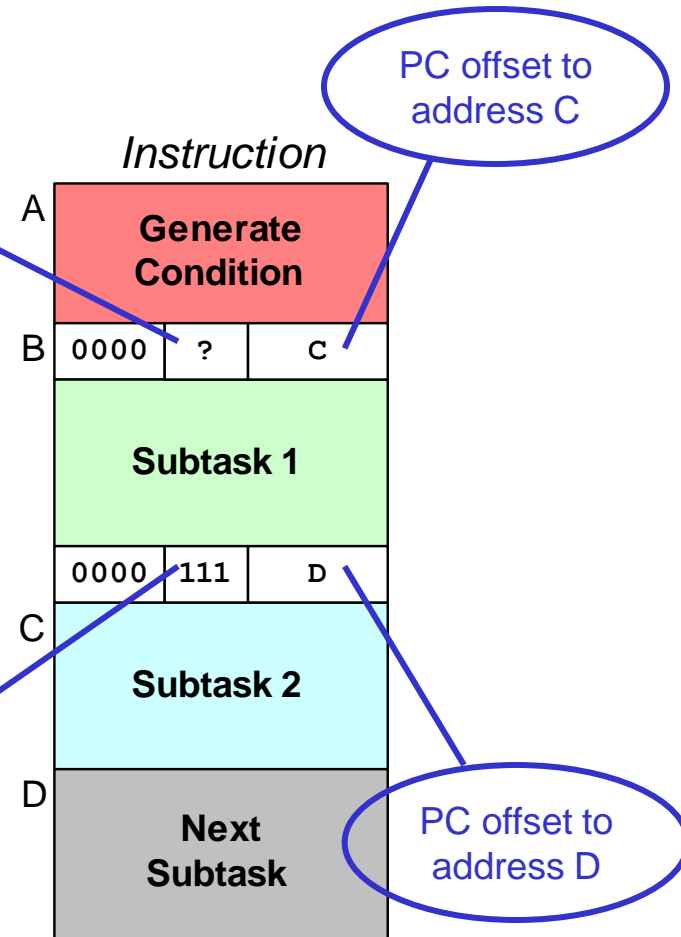

Assuming all addresses are close enough that PC-relative branch can be used.

Code for Iteration

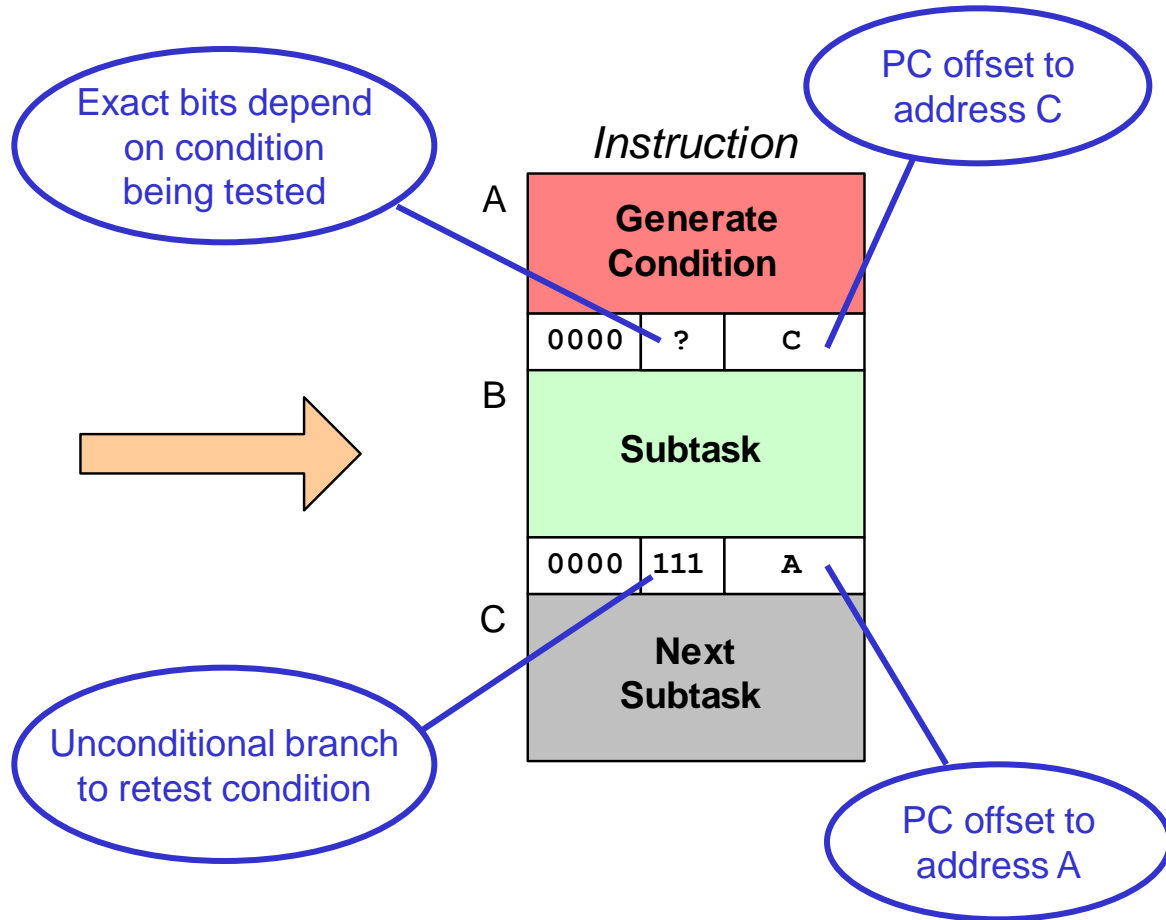
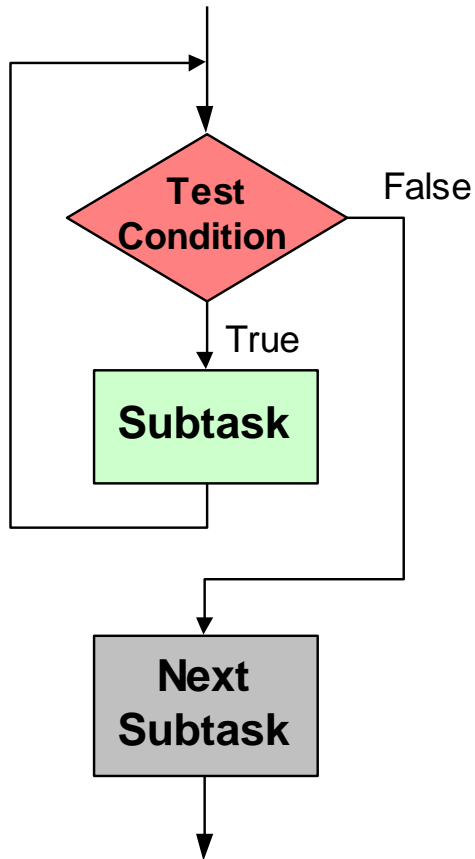

Assuming all addresses are on the same page.

Example: Counting Characters

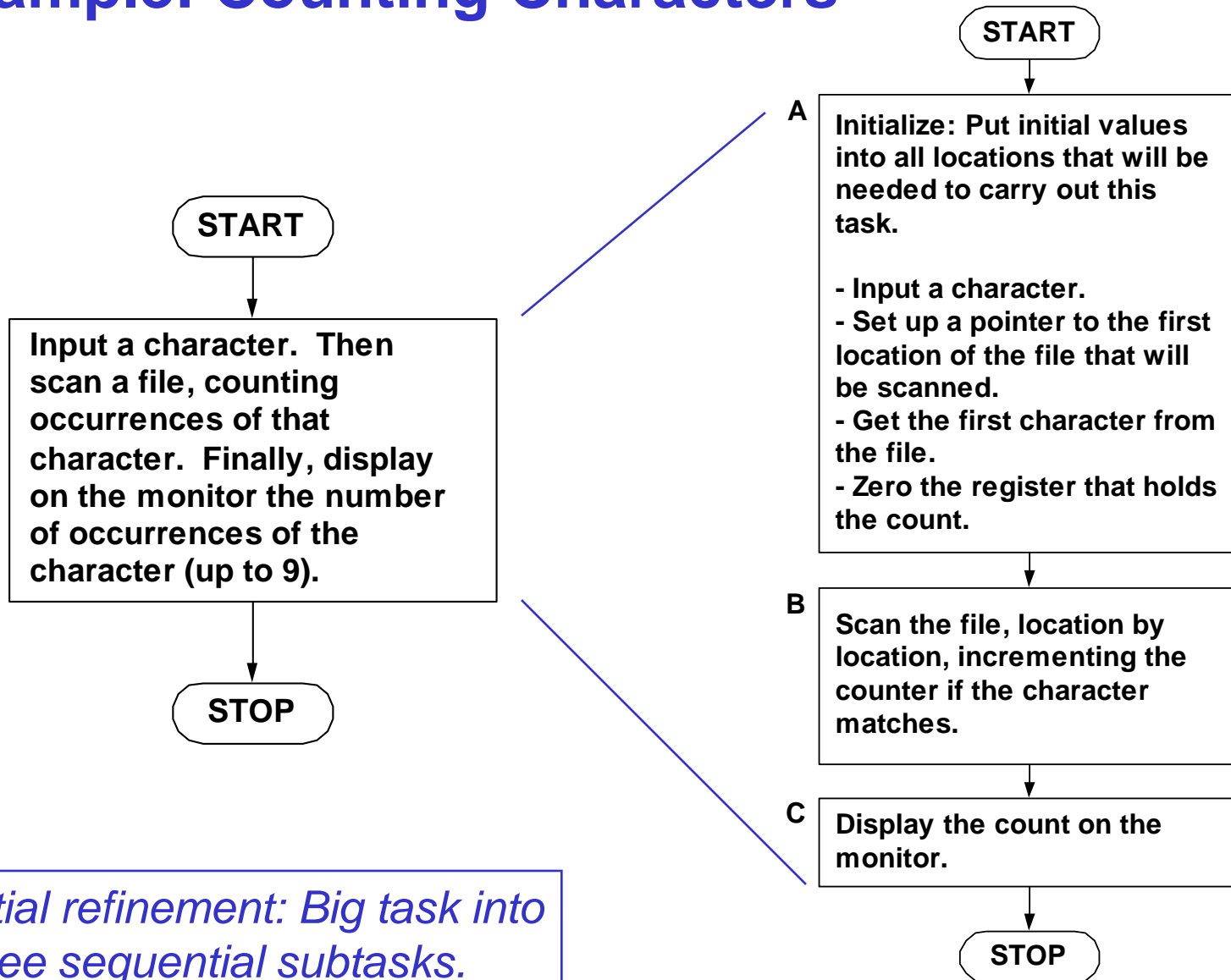

Initial refinement: Big task into three sequential subtasks.

Refining B

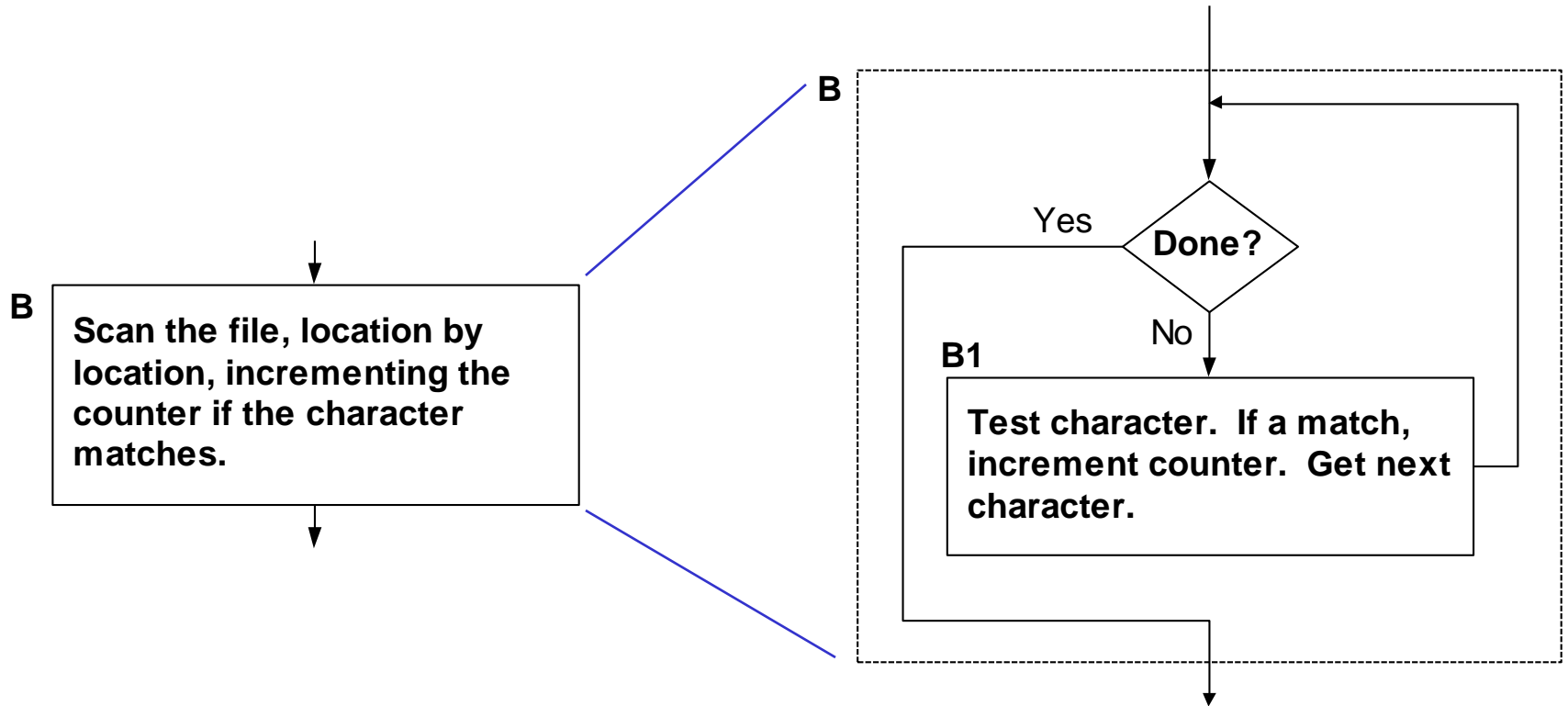

Refining B into iterative construct.

Refining B1

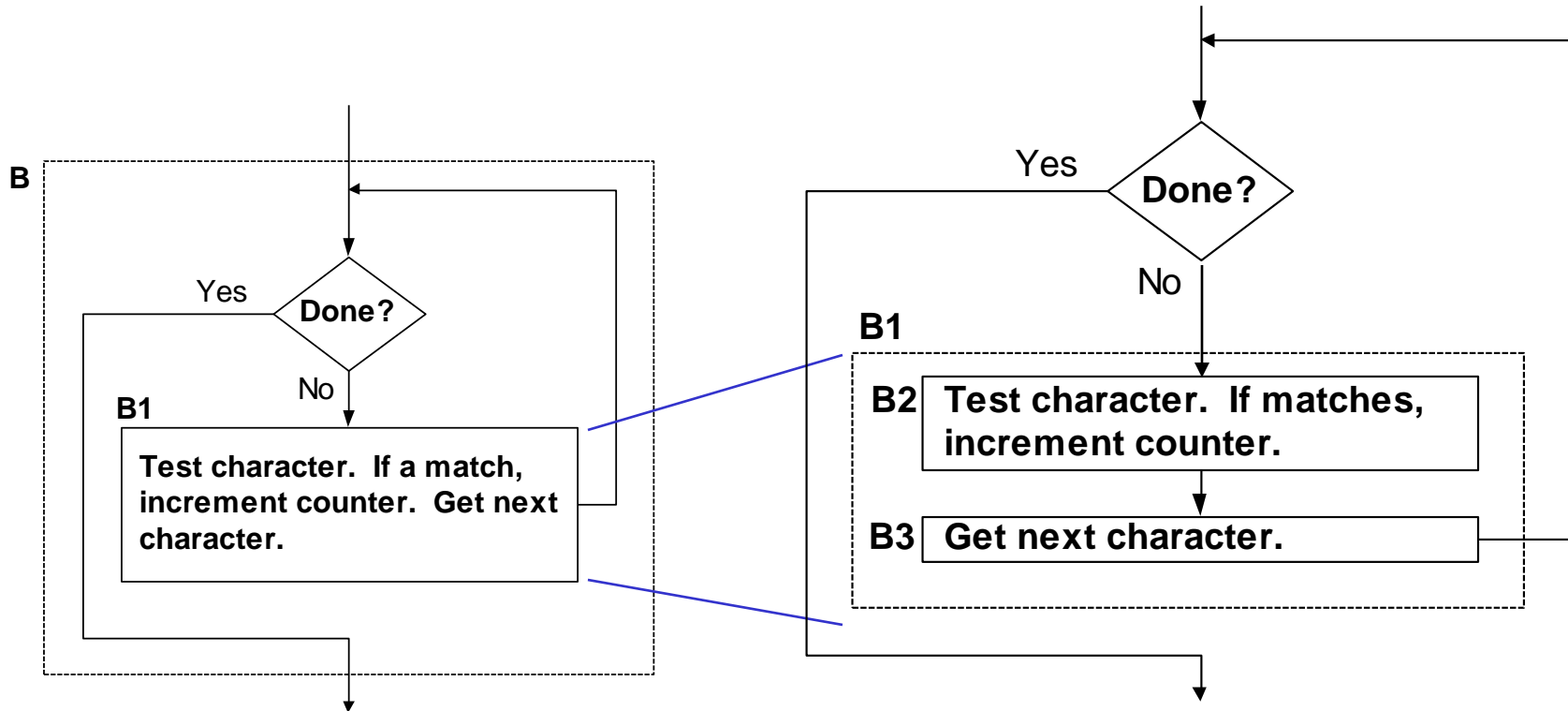

Refining B1 into sequential subtasks.

Refining B2 and B3

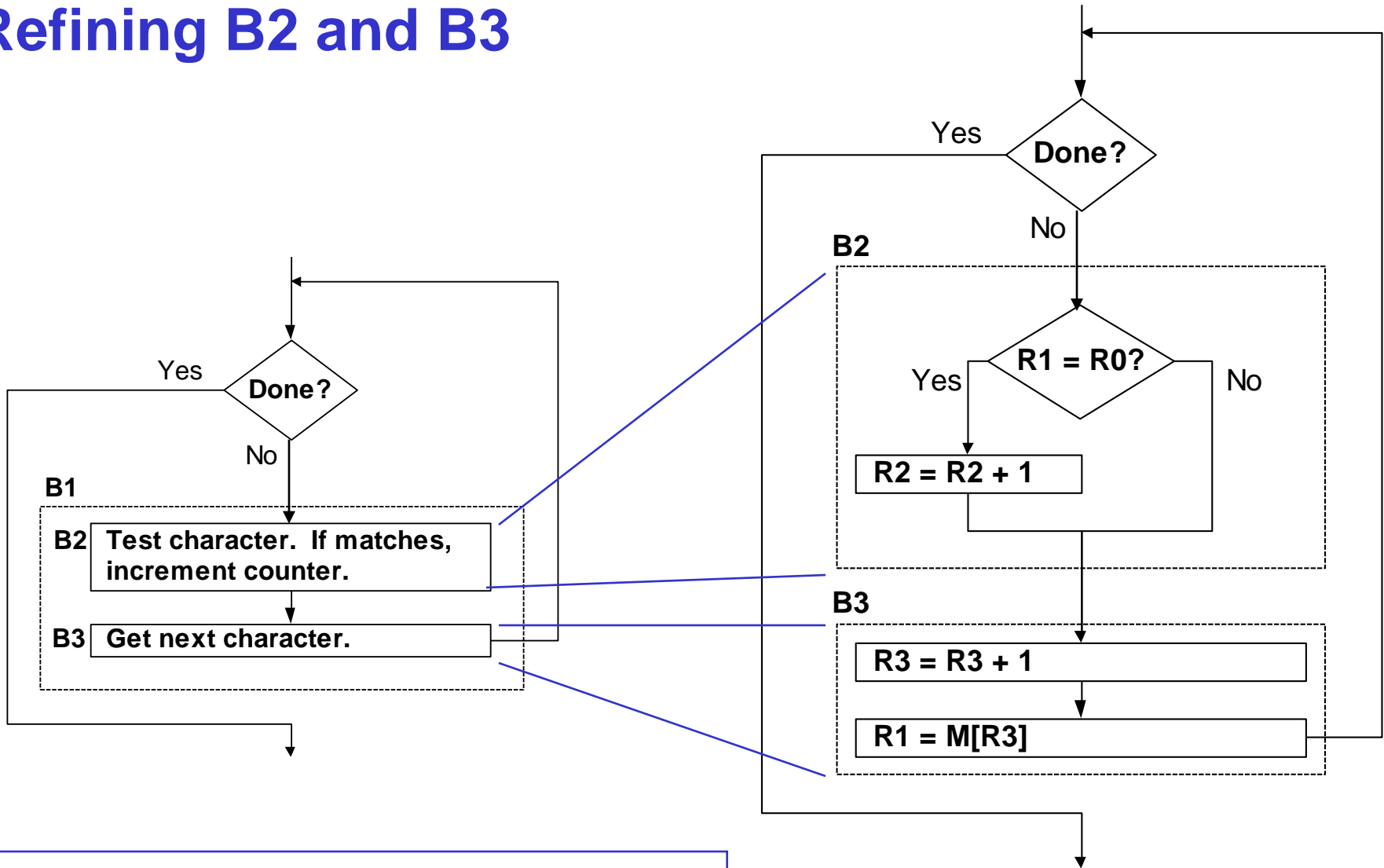

*Conditional (B2) and sequential (B3).
Use of LC-2 registers and instructions.*

The Last Step: LC-3 Instructions

Use comments to separate into modules and to document your code.

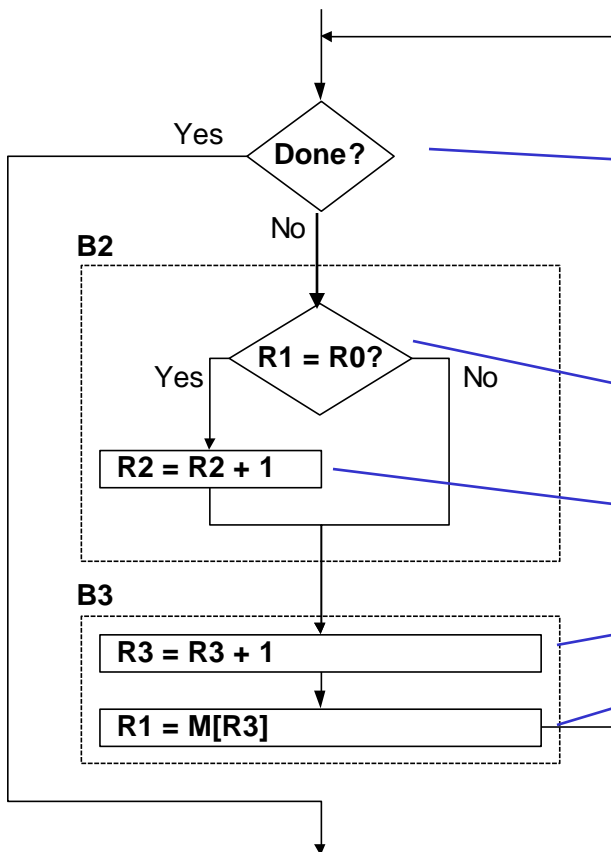

```
; Look at each char in file.
0001100001111100 ; is R1 = EOT?
0000010xxxxxxxxx ; if so, exit loop
; Check for match with R0.
1001001001111111 ; R1 = -char
0001001001100001
0001001000000001 ; R1 = R0 - char
0000101xxxxxxxxx ; no match, skip incr
0001010010100001 ; R2 = R2 + 1
; Incr file ptr and get next char
0001011011100001 ; R3 = R3 + 1
0110001011000000 ; R1 = M[R3]
```

Don't know
PCoffset bits until
all the code is done

Debugging

You've written your program and it doesn't work.

Now what?

What do you do when you're lost in a city?

- ✗ Drive around randomly and hope you find it?
- ✓ Return to a known point and look at a map?

In debugging, the equivalent to looking at a map is *tracing* your program.

- Examine the sequence of instructions being executed.
- Keep track of results being produced.
- Compare result from each instruction to the expected result.

Debugging Operations

Any debugging environment should provide means to:

- 1. Display values in memory and registers.**
- 2. Deposit values in memory and registers.**
- 3. Execute instruction sequence in a program.**
- 4. Stop execution when desired.**

Different programming levels offer different tools.

- High-level languages (C, Java, ...)
usually have source-code debugging tools.**
- For debugging at the machine instruction level:**
 - simulators**
 - operating system “monitor” tools**
 - in-circuit emulators (ICE)**
 - plug-in hardware replacements that give
instruction-level control**

LC-3 Simulator

execute instruction sequences

stop execution, set breakpoints

set/display registers and memory

The screenshot shows the LC-3 Simulator interface for a file named 'multiply.obj'. The window title is 'LC3 Simulator - multiply.obj'. The menu bar includes 'File', 'Execute', 'Simulate', and 'Help'. The toolbar contains several icons: a folder, a green arrow pointing down, a blue arrow pointing right, a blue arrow pointing left, a blue arrow pointing up, a red stop button, a red stop button with a plus sign, a '1000' button, and a blue arrow pointing right. A green circle highlights the first four icons, and a red circle highlights the red stop button and the red stop button with a plus sign. A red arrow points from the text 'stop execution, set breakpoints' to the red stop button with a plus sign. A blue bracket on the left side of the window encompasses the register and memory display area, with the text 'set/display registers and memory' next to it. The status bar at the bottom shows 'multiply.obj', '0 instructions executed', and 'Idle'. The main display area shows the following data:

Register	Value	Register	Value	PC	Value	IR	Value	
R0	x0000	0	R4	x0000	0	PC	x3200	12800
R1	x0000	0	R5	x0000	0	IR	x0000	0
R2	x0000	0	R6	x0000	0	PSR	x8002	-3276
R3	x0000	0	R7	x0000	0	CC	Z	

Address	Hex	Binary	Hex	Instruction
→ x3200	0101010010100000	x54A0	AND	R2, R2, #0
▪ x3201	0001010010000100	x1484	ADD	R2, R2, R4
▪ x3202	0001101101111111	x1B7F	ADD	R5, R5, #-1
▪ x3203	0000011111111101	x07FD	BRZP	x3201
▪ x3204	1111000000100101	xF025	TRAP	HALT
▪ x3205	0000000000000000	x0000	NOP	
▪ x3206	0000000000000000	x0000	NOP	

Types of Errors

Syntax Errors

- You made a typing error that resulted in an illegal operation.
- Not usually an issue with machine language, because almost any bit pattern corresponds to some legal instruction.
- In high-level languages, these are often caught during the translation from language to machine code.

Logic Errors

- Your program is legal, but wrong, so the results don't match the problem statement.
- Trace the program to see what's really happening and determine how to get the proper behavior.

Data Errors

- Input data is different than what you expected.
- Test the program with a wide variety of inputs.

Tracing the Program

Execute the program one piece at a time, examining register and memory to see results at each step.

Single-Stepping

- Execute one instruction at a time.
- Tedious, but useful to help you verify each step of your program.

Breakpoints

- Tell the simulator to stop executing when it reaches a specific instruction.
- Check overall results at specific points in the program.
 - Lets you quickly execute sequences to get a high-level overview of the execution behavior.
 - Quickly execute sequences that you believe are correct.

Watchpoints

- Tell the simulator to stop when a register or memory location changes or when it equals a specific value.
- Useful when you don't know where or when a value is changed.

Example 1: Multiply

This program is supposed to multiply the two unsigned integers in R4 and R5.

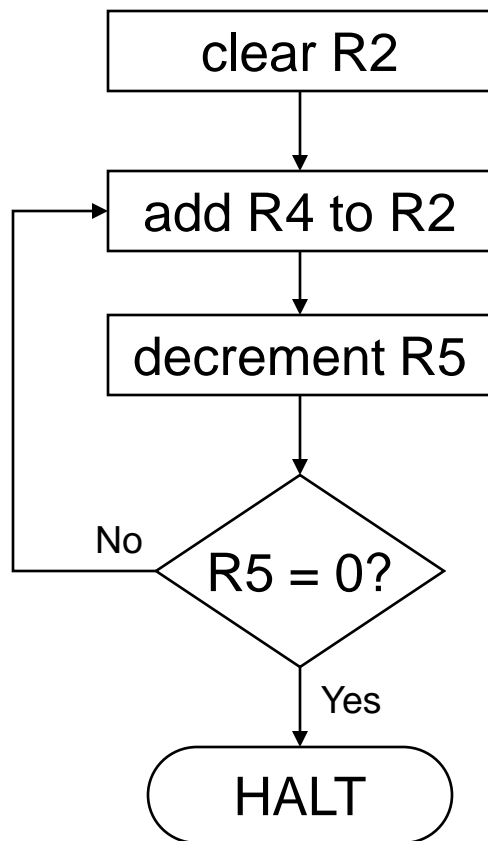

x3200	0101010010100000
x3201	0001010010000100
x3202	0001101101111111
x3203	0000011111111101
x3204	1111000000100101

**Set R4 = 10, R5 = 3.
Run program.
Result: R2 = 40, not 30.**

Debugging the Multiply Program

PC and registers
at the beginning
of each instruction

PC	R2	R4	R5
x3200	--	10	3
x3201	0	10	3
x3202	10	10	3
x3203	10	10	2
x3201	10	10	2
x3202	20	10	2
x3203	20	10	1
x3201	20	10	1
x3202	30	10	1
x3203	30	10	0
x3201	30	10	0
x3202	40	10	0
x3203	40	10	-1
x3204	40	10	-1
	40	10	-1

Single-stepping

Breakpoint at branch (x3203)

PC	R2	R4	R5
x3203	10	10	2
x3203	20	10	1
x3203	30	10	0
x3203	40	10	-1
	40	10	-1

Should stop looping here!

Executing loop one time too many.
Branch at x3203 should be based
on P bit only, not Z and P.

Example 2: Summing an Array of Numbers

This program is supposed to sum the numbers stored in 10 locations beginning with x3100, leaving the result in R1.

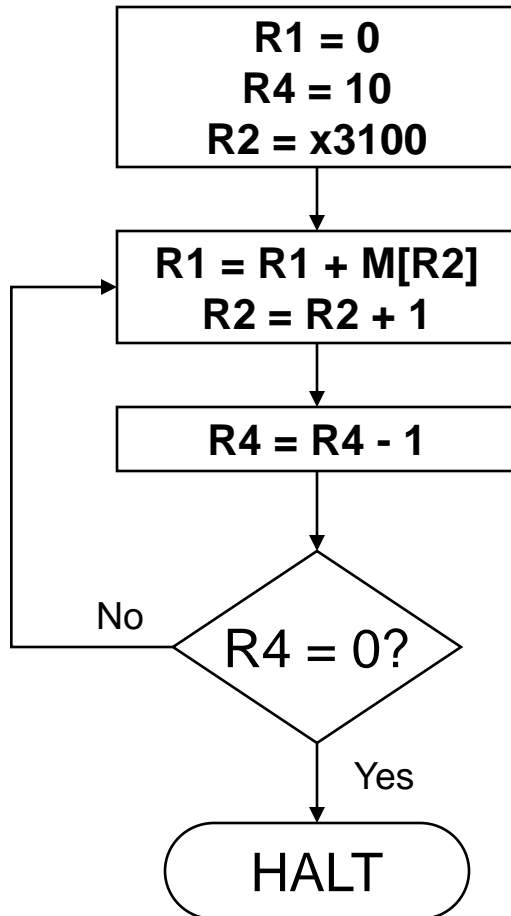

x3000	0101001001100000
x3001	0101100100100000
x3002	0001100100101010
x3003	0010010011111100
x3004	0110011010000000
x3005	0001010010100001
x3006	0001001001000011
x3007	0001100100111111
x3008	0000001111111011
x3009	1111000000100101

Debugging the Summing Program

Running the the data below yields **R1 = x0024**, but the sum should be **x8135**. What happened?

Address	Contents
x3100	x3107
x3101	x2819
x3102	x0110
x3103	x0310
x3104	x0110
x3105	x1110
x3106	x11B1
x3107	x0019
x3108	x0007
x3109	x0004

Start single-stepping program...

PC	R1	R2	R4
x3000	--	--	--
x3001	0	--	--
x3002	0	--	0
x3003	0	--	10
x3004	0	x3107	10

↑
Should be x3100!

Loading contents of M[x3100], not address.
Change opcode of x3003
from 0010 (LD) to 1110 (LEA).

Example 3: Looking for a 5

This program is supposed to set $R0=1$ if there's a 5 in one ten memory locations, starting at $x3100$. Else, it should set $R0$ to 0.

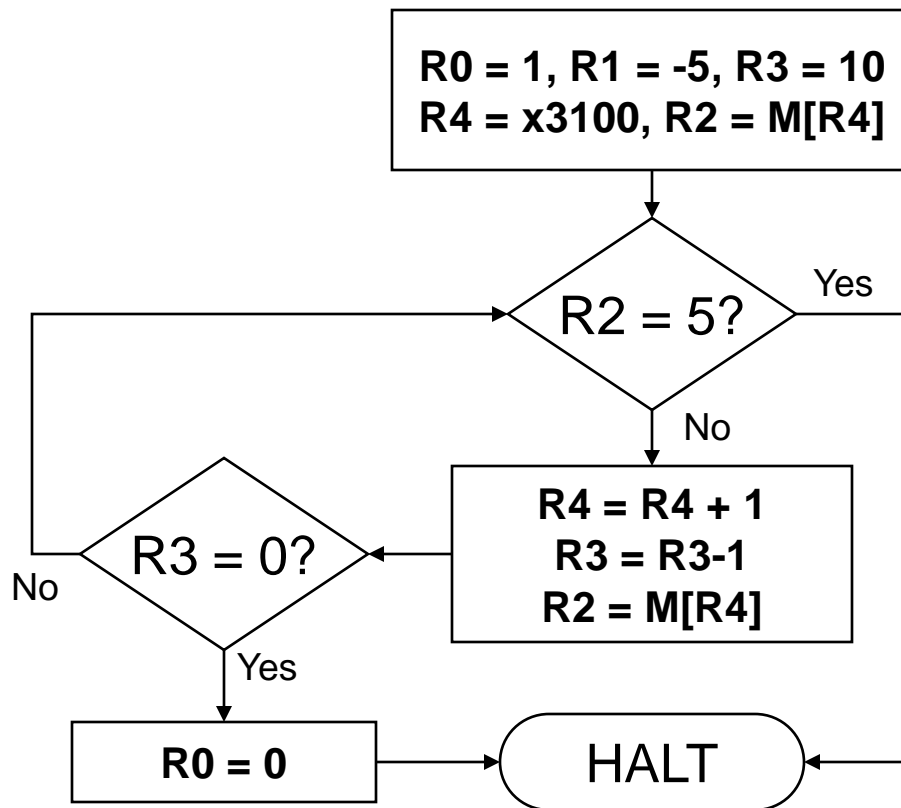

x3000	0101000000100000
x3001	0001000000100001
x3002	0101001001100000
x3003	0001001001111011
x3004	0101011011100000
x3005	0001011011101010
x3006	0010100000001001
x3007	0110010100000000
x3008	0001010010000001
x3009	0000010000000101
x300A	0001100100100001
x300B	0001011011111111
x300C	0110010100000000
x300D	0000001111111010
x300E	0101000000100000
x300F	1111000000100101
x3010	0011000100000000

Debugging the Fives Program

Running the program with a 5 in location x3108 results in **R0 = 0**, not **R0 = 1**. What happened?

Address	Contents
x3100	9
x3101	7
x3102	32
x3103	0
x3104	-8
x3105	19
x3106	6
x3107	13
x3108	5
x3109	61

Perhaps we didn't look at all the data?
 Put a breakpoint at x300D to see how many times we branch back.

PC	R0	R2	R3	R4
x300D	1	7	9	x3101
x300D	1	32	8	x3102
x300D	1	0	7	x3103
	0	0	7	x3103

← Didn't branch back, even though R3 > 0?

Branch uses condition code set by loading R2 with M[R4], not by decrementing R3. Swap x300B and x300C, or remove x300C and branch back to x3007.

Example 4: Finding First 1 in a Word

This program is supposed to return (in R1) the bit position of the first 1 in a word. The address of the word is in location x3009 (just past the end of the program). If there are no ones, R1 should be set to -1.

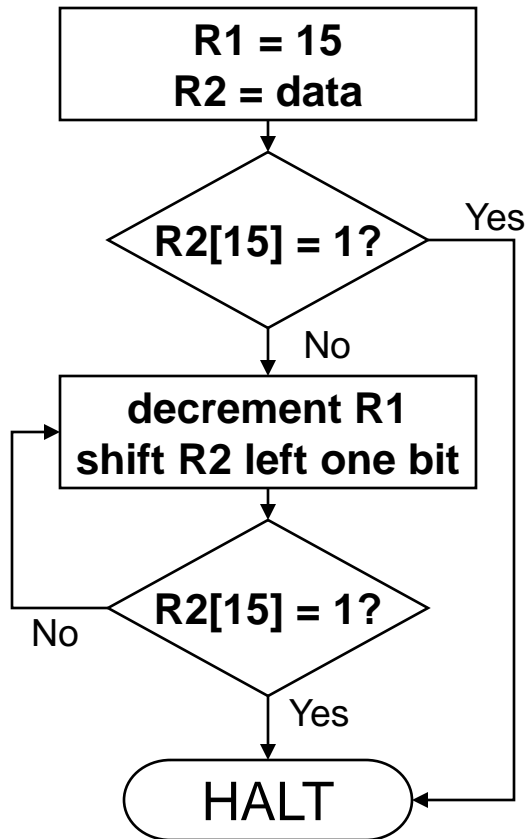

x3000	0101001001100000
x3001	0001001001101111
x3002	1010010000000110
x3003	0000100000000100
x3004	0001001001111111
x3005	0001010010000010
x3006	0000100000000001
x3007	0000111111111100
x3008	1111000000100101
x3009	0011000100000000

Debugging the First-One Program

Program works most of the time, but if data is zero, it never seems to HALT.

Breakpoint at backwards branch (x3007)

PC	R1
x3007	14
x3007	13
x3007	12
x3007	11
x3007	10
x3007	9
x3007	8
x3007	7
x3007	6
x3007	5

PC	R1
x3007	4
x3007	3
x3007	2
x3007	1
x3007	0
x3007	-1
x3007	-2
x3007	-3
x3007	-4
x3007	-5

If no ones, then branch to HALT never occurs!

This is called an “infinite loop.”
Must change algorithm to either
(a) check for special case ($R2=0$), or
(b) exit loop if $R1 < 0$.

Debugging: Lessons Learned

Trace program to see what's going on.

- Breakpoints, single-stepping

When tracing, make sure to notice what's really happening, not what you think should happen.

- In summing program, it would be easy to not notice that address x3107 was loaded instead of x3100.

Test your program using a variety of input data.

- In Examples 3 and 4, the program works for many data sets.
- Be sure to test extreme cases (all ones, no ones, ...).